

MF-MM

STIHL

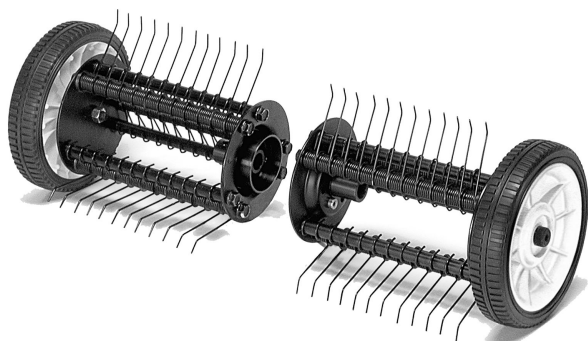

2 - 11 Instruction Manual



Contents

1	MultiSystem.....	2
2	Guide to Using this Manual.....	2
3	Safety Precautions and Working Techniques.....	2
4	Using the Unit.....	6
5	Approved MultiEngines.....	7
6	Mounting the MultiTool.....	7
7	Mounting the Deflector.....	8
8	Starting / Stopping the Engine.....	8
9	Replacing Spring Tines.....	9
10	Storing the Machine.....	9
11	Maintenance and Care.....	9
12	Minimize Wear and Avoid Damage.....	9
13	Main Parts.....	10
14	Specifications.....	10
15	Maintenance and Repairs.....	10
16	Disposal.....	11

1 MultiSystem

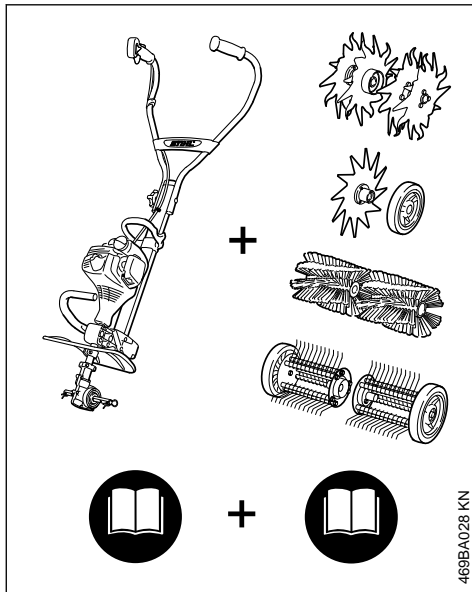

In the STIHL MultiSystem, various MultiEngines and MultiTools are combined to form a machine. In this Instruction Manual, the functional unit of MultiEngine **and** MultiTool is referred to as a machine.

Accordingly, the instruction manuals for the MultiEngine and the MultiTool constitute the entire Instruction Manual for the machine.

Always read **both** manuals carefully before using your machine for the first time and keep them safe for future reference.

2 Guide to Using this Manual

2.1 Pictograms

All the pictograms attached to the machine are shown and explained in this manual.

2.2 Symbols in text

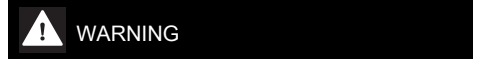

Warning where there is a risk of an accident or personal injury or serious damage to property.

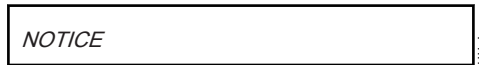

Caution where there is a risk of damaging the machine or its individual components.

2.3 Engineering improvements

STIHL's philosophy is to continually improve all of its products. For this reason we may modify the design, engineering and appearance of our products periodically.

Therefore, some changes, modifications and improvements may not be covered in this manual.

3 Safety Precautions and Working Techniques



Some special safety precautions must be observed to reduce the risk of personal injury when operating the dethatcher because of the high speed of its rotating tines.



Always read and and make sure you understand both user manuals (MultiEngine and MultiTool) before using your power tool for the first time, and keep them in a safe place for future reference. Non-compliance with the user manuals may cause serious or even fatal injury.

Lend or rent your power tool only to persons who are familiar with this model and its operation – do not lend or rent your power tool without the MultiEngine and MultiTool user manuals.

Use the dethatcher only for removing old, dried cuttings, moss, grass or root residue from lawns.

The machine must not be used for any other purposes – **risk of accidents!**

Only use attachments and accessories that are explicitly approved for this power tool model by STIHL or are technically identical. If you have any questions in this respect, consult your dealer.

Use only high-quality parts and accessories, in order to avoid the risk of accidents and damage to the machine.

STIHL recommends the use of genuine STIHL replacement parts. They are specifically designed to match the product and meet your performance requirements.

The deflector on this power tool cannot protect the operator from all objects thrown by the attachment (stones, glass, wire, etc.). Ejected objects may also ricochet and strike the operator.

Never attempt to modify your power tool in any way since this may increase the risk of personal injury. STIHL excludes all liability for personal injury and damage to property caused while using unauthorized attachments.

Do not use a high-pressure washer to clean the power tool. The solid jet of water may damage parts of the unit.

3.1 Clothing and equipment

Wear proper protective clothing and equipment.



Clothing must be robust but allow complete freedom of movement. Wear close-fitting clothes such as a boiler suit, not a loose jacket.

Do not wear clothing which could become trapped in wood, brush or moving parts of the machine. Do not wear a scarf, necktie or jewelry. Tie up and confine long hair above your shoulders.



Wear sturdy shoes with non-slip soles.



WARNING



To reduce the risk of eye injuries, wear close-fitting safety glasses in accordance with European Standard EN 166. Make sure the safety glasses are a snug fit.

Wear "personal" sound protection, e.g. ear defenders.



Wear sturdy protective gloves made of a resistant material (e. g. leather).

STIHL can supply a comprehensive range of personal protective equipment.

3.2 Transporting the machine

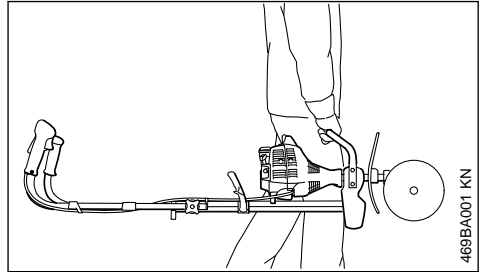

Always stop the engine.

Carry your power tool by the handle, attachment in front of you.

Do not touch hot parts of the machine - **risk of burn injury!**

By vehicle: When transporting in a vehicle, properly secure your machine to prevent tipping over, damage and fuel spillage.

The power tool may be dragged backwards (opposite to the normal direction of operation) for short distances. Never attempt to move it around by pushing it forward as **this could result in damage**. The spring tines might break.

3.3 Before starting

Check that your power tool is properly assembled and in good condition – refer to the appropriate chapters in the MultiEngine and MultiTool user manuals.

- Attachment correctly and securely mounted and in good condition (clean, moves freely, not warped)
- Mount both deflector extensions and mud flap.
- Inspect the deflectors for damage and wear. Do not use the machine with a damaged deflector – replace damaged parts
- Never attempt to modify the controls or safety devices.
- Keep the handles dry and clean – free from oil and dirt – this is important for safe control of the machine
- Swing the bike handle to the normal operating position and tighten it down firmly with the

rotary knob. See chapter on "Adjusting the Bike Handle" in the MultiEngine user manual.

To reduce the risk of personal injury, do not operate your power tool if it is damaged or not properly assembled!

Check the gearbox for correct position, adjust if necessary. This helps reduce the risk of injury **from the MultiTool rotating in the wrong direction**.

See also notes on "Mounting the MultiTool".

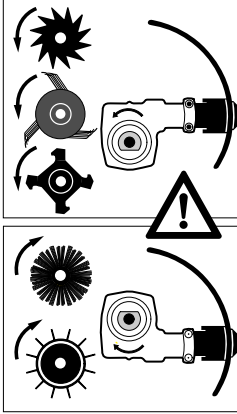

If you use metal tools, position the gearbox so that the axle is below the drive shaft.

Use this position for:

- BF-MM cultivator
- BK-MM bolo tines
- FC-MM edger
- RL-MM aerator
- MF-MM dethatcher

3.4 Holding and guiding the machine

Make sure you always have a firm and secure footing.

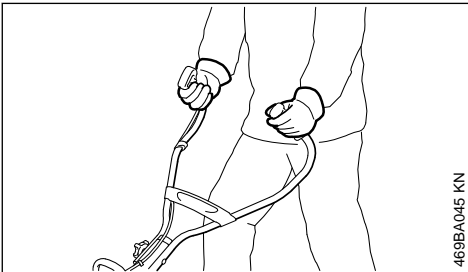

469BA045 KN

Always hold the unit firmly with both hands on the handles.

Right hand on control handle, left hand on grip on handlebar.

3.5 While working

In the event of impending danger or in an emergency, switch off the engine immediately by moving the slide control / stop switch/button to **0** or **STOP**.



To reduce the **risk of injury** from contact with the tool and ejected objects, do not allow any other persons within a radius of 5 meters of your own position. This distance must also be maintained in relation to objects (vehicles, window panes) – **risk of property damage!**

The correct engine idle speed is important to ensure that the attachment stops moving when you let go of the throttle trigger. Check and correct the idle speed setting at regular intervals. If the attachment still rotates when the engine is idling, have your dealer check your machine and make proper adjustments or repairs – see Multi-Engine user manual.



The gear head becomes hot during operation. **To reduce the risk of burn injury, do not touch the gear housing!**

To reduce the risk of injury from thrown objects or contact with the attachment, never operate the unit without a properly mounted deflector designed specifically for the unit and the attachment.

Always stand behind the deflector or to one side of the machine during operation – never in front of the attachment.

Do not push attachments into the ground.

Take special care in slippery conditions – **wet or icy**, on slopes or uneven ground etc.

To reduce the **risk of accidents or injury**, remove all obstacles and objects from the work area.

Inspect the work area – solid objects (stones, pieces of metal, etc.) may damage the attachment.



To avoid the risk of electrocution, never use your power tool in areas where electrical lines are laid on the surface or buried just below the surface. Striking and damaging such lines with the attachment could cause serious or even **fatal injury**.

Operate your power tool at normal walking pace only.

Be extremely cautious when pulling the power tool towards you **because of the risk of injury** from contact with the rotating attachment.

Make sure you always have a firm and secure footing.

Be extremely cautious when changing direction with the power tool – especially on slopes.

On slopes, always work parallel to the gradient **to reduce the risk of injury** from slipping or contact with the attachment.

Never work on steep slopes because of the **risk of injury** through loss of control of the power tool.

Take particular care when working close to fences, walls, stones, roots, trees and areas of dense growth. Solid objects could be thrown in your direction or may damage the attachment – **risk of accident!**

When working next to high scrub, bushes and hedges, avoid harming animals!

Be particularly alert and cautious when wearing hearing protection because your ability to hear warnings (shouts, alarms, etc.) is restricted.

Take breaks when you start getting tired or feeling fatigue – **risk of accidents!**

Work calmly and carefully – in daylight conditions and only when visibility is good. Proceed with caution, do not put others in danger.

If your power tool is subjected to unusually high loads for which it was not designed (e.g. heavy impact or a fall), always check that it is in good condition before continuing work – see also "Before Starting". Make sure the safety devices are working properly. Never use a power tool that is no longer safe to operate. In case of doubt, contact a dealer.

Do not touch the attachment while the engine is running. If the attachment becomes jammed by an obstruction, switch off the engine immediately before attempting to remove the obstruction – otherwise, **risk of injury!**

Opening the throttle while the attachment is blocked increases the load and reduces engine speed. This causes the clutch to then slip continuously which leads to overheating and damage to important components (e.g. clutch, polymer housing components) – and this can increase the **risk of injury** from the attachment moving while the engine is idling.

Check the attachment at frequent regular intervals during operation or immediately if there is a noticeable change in behavior:

- Shut off the engine, hold the machine securely.
- Check condition and tightness, look for broken spring tines.
- Replace damaged spring tines immediately.

Clean the attachment and deflector at regular intervals during operation.

- Shut off the engine
- Use gloves
- Remove grass, weeds and scrub, etc.

To reduce the risk of injury, shut off the engine before changing attachments.

Never continue using or attempt to repair damaged or cracked spring tines.

3.6 After finishing work

After finishing work or before leaving the power tool unattended: Shut off the engine.

After finishing work, clean dirt, soil and plant residue off the attachment – wear gloves **to reduce the risk of injury**.

Do not use any grease solvents when cleaning.

After thoroughly cleaning, coat metal surface of attachments with a corrosion inhibitor.

3.7 Maintenance and Repairs

Service the machine regularly. Do not attempt any maintenance or repair work not described in the MultiTool and MultiEngine instruction manuals. Have all other work performed by a servicing dealer.

STIHL recommends that you have servicing and repair work carried out exclusively by an authorized STIHL servicing dealer. STIHL dealers are regularly given the opportunity to attend training courses and are supplied with the necessary technical information.

Only use high-quality replacement parts in order to avoid the risk of accidents and damage to the

power tool. If you have any questions in this respect, consult a servicing dealer.

STIHL recommends the use of original STIHL replacement parts. They are specifically designed to match your model and meet your performance requirements.

To reduce the risk of injury, **always shut off the engine** before carrying out any maintenance or repairs or cleaning the machine.

4 Using the Unit



483BA001 KN

The MF-MM dethatcher MultiTool is designed to remove old, dried cuttings, moss, grass or root residue from lawns.

4.1 Preparations

If the lawn is very dry, spray it with water before you start work: this softens the soil a little and reduces the amount of dust created.

If the grass is longer than about 5 cm, mow it before using the dethatcher.

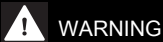

WARNING

Clear away all obstacles and solid objects from the work area.

- ▶ Plan the route to be taken.

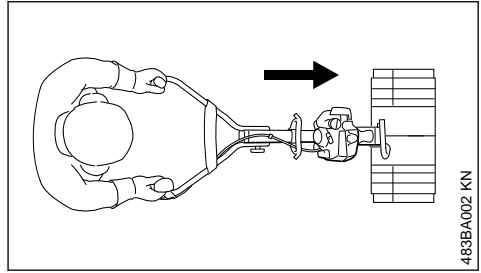

483BA002 KN

Operate the MultiEngine with MF-MM dethatcher in the forward direction only.

The attachments may only be rotate in one direction. Arrows on the flanges show the correct direction of rotation – see chapter on "Mounting the MultiTool".

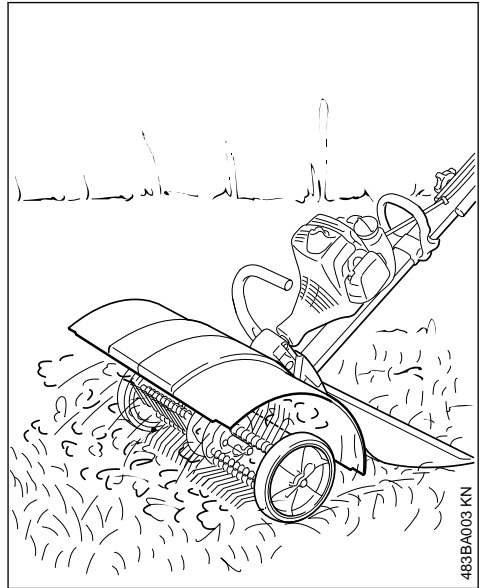

483BA003 KN



WARNING

Never work without the deflector, both deflector extensions and the mud flap.

These devices divert loosened and cut material away from the machine and the operator.

4.2 Operation

- ▶ Secure the handlebar in the normal operating position.
- ▶ Start the engine.
- ▶ Work with the engine running at full throttle.

- ▶ Walk at a pace that achieves the required result without lugging down the engine.
- ▶ Operate at no more than a normal walking pace.

4.3 Cleaning the Dethatcher

Parts of plants, such as grass or roots, may become tightly wound around the tool mounting and the attachment itself. Clean the attachment as follows:

- Shut off the engine.
- Wear work gloves.
- Remove the inner hitch pins from the shaft.
- Pull the dethatcher off the shaft.
- Remove the outer hitch pin (wheel) from the shaft.
- Pull off the wheel.
- Remove pieces of roots, plants and soil.

Refer to "Mounting the MultiTool" for mounting instructions.

5 Approved MultiEngines

Only use MultiEngines supplied by STIHL or expressly approved by STIHL for use with the MultiTool.

This MultiTool may only be used in combination with the STIHL MM 56 MultiEngine.

6 Mounting the MultiTool

6.1 Removing Existing MultiTools

! WARNING

Wear gloves – **risk of injury** from sharp, pointed MultiTools and/or hot gearbox surfaces.

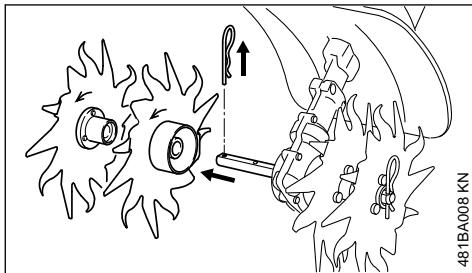

- ▶ Remove the hitch pins and pull the MultiTools (if fitted) off the axle – see also "Installing the MultiTool" in the User Manual of the other MultiTool.
- ▶ Clean the gearbox if necessary

6.2 Checking Position of Gearbox

! WARNING

Check and potentially adjust the gearbox position – **risk of injury** by the MultiTool rotating in the wrong direction!

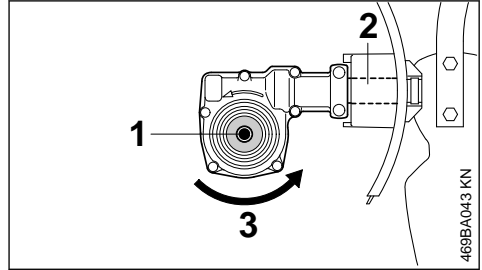

The axle (1) must be below the shaft (2).

Direction of rotation (3) of MultiTool.

6.3 Adjusting Position of Gearbox

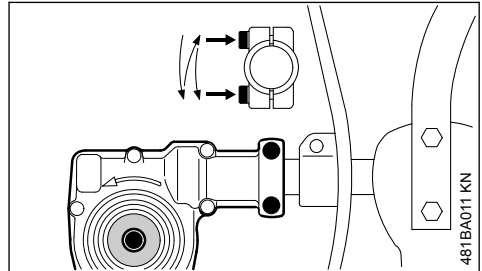

- ▶ Loosen clamp screws on gearbox.
- ▶ Turn the gearbox 180°.
- ▶ Line up the gearbox in the correct position
- ▶ Tighten the two clamping screws as illustrated in the diagram below:
 - Tighten the first screw slightly
 - Tighten the second screw slightly
 - Tighten first screw securely
 - Tighten second screw securely

NOTICE

It must not be possible to rotate the gearbox on the shaft.

6.4 Installing the MultiTool

Left-hand and right-hand dethatchers are different. The direction of rotation is marked with arrows on the gear and flange. Make sure the arrows point in the same direction.

NOTICE

The spring tines may break or be damaged if the direction of rotation is wrong.

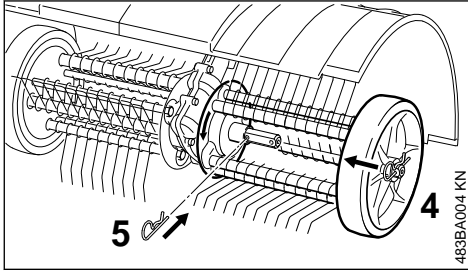

- ▶ Rotate the left-hand dethatcher (4) on the shaft until it can be pushed into position – in this process, check the direction of rotation (arrows).
- ▶ Insert hitch pin (5) in hole in shaft and snap it into position.
- ▶ Mount the right-hand dethatcher in the same way.

7 Mounting the Deflector

7.1 Mounting and Removing the Deflector Extensions

Mounting

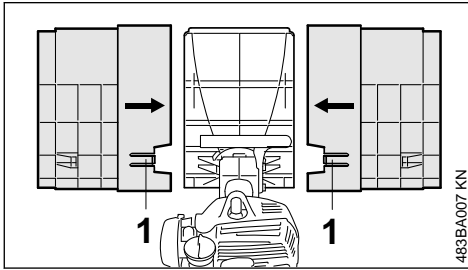

- ▶ Slide both deflector extensions onto the right and left sides of the deflector, push them fully home at the top and bottom and engage the tab (1).

Removing

- ▶ Use the combination wrench to disengage the tabs (1) and then pull off the extensions.

! WARNING

The deflector extensions divert removed material and debris away from the machine and the operator. Never work without a properly mounted deflector extensions.

7.2 Installing and Removing the Mud Flap

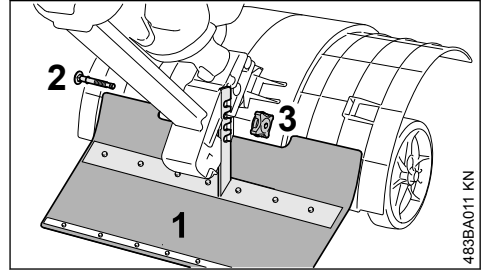

- ▶ Secure the mud flap (1) with screw (2) and rotary knob (3) to the right-hand side of the flange.
- ▶ Adjust the mud flap to the required length so that it overlaps the deflector.
- ▶ Tighten down the rotary knob firmly.

! WARNING

The mud flap diverts removed material and debris away from the machine and the operator. Never work without a properly mounted mud flap.

8 Starting / Stopping the Engine

8.1 Starting the Engine

Always follow the starting procedure described in the MultiEngine instruction manual.

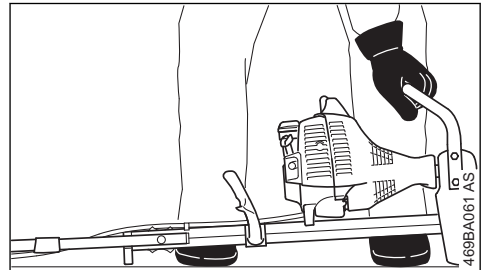

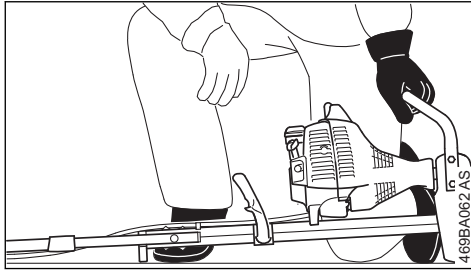

- ▶ Secure the handlebar in the normal operating position.
- ▶ Retract the wheels, if fitted – see chapter on "Wheels" in MultiEngine instruction manual.
- ▶ Retract the spur, if fitted.
- ▶ Check that the MultiTool is not touching the ground or any other obstacles. The unit must rest on the engine flange and the support on the frame.
- ▶ Make sure you have good balance and secure footing – as shown in the illustration.

WARNING

To reduce the risk of injury from contact with the **rotating attachment**, always stand to the side of the power tool, never in front of the attachment.

- ▶ With your left hand on the loop handle, press the unit **firmly** against the ground – do not touch the throttle trigger or lockout lever.

NOTICE

Do not stand or kneel on the handlebar or frame.

WARNING

The attachment may begin to move as soon as the engine starts. For this reason, blip the throttle after starting – the engine returns to idling speed.

Now follow the starting procedure described in the MultiEngine instruction manual.

8.2 Stopping the Engine

- ▶ See MultiEngine instruction manual.

9 Replacing Spring Tines

Replace individual spring tines if they are severely damaged or broken.

- ▶ Remove the dethatcher – see "Mounting the MultiTool".

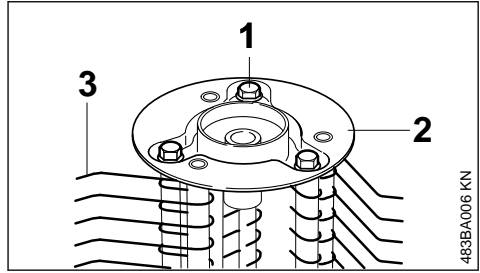

- ▶ Loosen the screws (1) on the dethatcher.
- ▶ Remove the flange (2).

Spring tines and washers are fitted alternately on the tubes.

- ▶ Pull off the spring tines (3) and washers.
- ▶ Replace damaged spring tines.
- ▶ Fit spring tines and washers on the tubes until they are full.
- ▶ Fit the flange (2).
- ▶ Tighten down the screws (1) firmly.
- ▶ Mount the dethatcher – see "Mounting the MultiTool".

10 Storing the Machine

For periods of about 30 days or longer

- ▶ Remove, clean and inspect the dethatcher with deflector extensions and mud flap.
- ▶ Store the tool in a dry and secure location. Keep out of the reach of children and other unauthorized persons

11 Maintenance and Care

The following intervals apply to normal operating conditions only. If your daily working time is longer or operating conditions are difficult (very dusty work area, etc.), shorten the specified intervals accordingly.

All accessible screws and nuts

- ▶ Retighten if necessary

Sweeping attachments and deflectors

- ▶ Visual inspection, check tightness before starting work and after every refueling stop
- ▶ Replace if damaged

Safety labels

- ▶ Replace illegible safety labels

12 Minimize Wear and Avoid Damage

Observing the instructions in this manual and the MultiEngine manual helps reduce the risk of

unnecessary wear and damage to the power tool.

The power tool must be operated, maintained and stored with the due care and attention described in these instruction manuals.

The user is responsible for all damage caused by non-observance of the safety precautions, operating and maintenance instructions. This includes in particular:

- Alterations or modifications to the product not approved by STIHL.
- Using tools or accessories which are neither approved or suitable for the product or are of a poor quality.
- Using the product for purposes for which it was not designed.
- Using the product for sports or competitive events.
- Consequential damage caused by continuing to use the product with defective components.

12.1 Maintenance Work

All the operations described in the chapter on "Maintenance and Care" must be performed on a regular basis. If these maintenance operations cannot be performed by the owner, they should be performed by a servicing dealer.

STIHL recommends that you have servicing and repair work carried out exclusively by an authorized STIHL servicing dealer. STIHL dealers are regularly given the opportunity to attend training courses and are supplied with the necessary technical information.

If these maintenance operations are not carried out as specified, the user assumes responsibility for any damage that may occur. Among other parts, this includes:

- Corrosion and other consequential damage resulting from improper storage.
- Damage to the product resulting from the use of poor quality replacement parts.

12.2 Parts Subject to Wear and Tear

Some parts of the power tool are subject to normal wear and tear even during regular operation in accordance with instructions and, depending on the type and duration of use, have to be replaced in good time. Among other parts, this includes:

- Spring tines
- Mounting hardware for spring tines
- Deflector extensions
- Mud flap

13 Main Parts

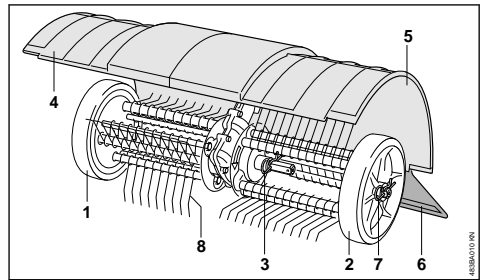

- 1 Right-hand wheel
- 2 Left-hand wheel
- 3 Inner hitch pin, left
- 4 Deflector extension, right
- 5 Deflector extension, left
- 6 Skirt
- 7 Outer hitch pin, left
- 8 Spring tines

14 Specifications

14.1 Attachment

Dethatcher, left, right
Working width: 500 mm

14.2 Weight

Dethatcher with deflector extensions and mud flap 8.6 kg

14.3 REACH

REACH is an EC regulation and stands for the Registration, Evaluation, Authorization and Restriction of Chemical substances.

For information on compliance with the REACH regulation (EC) No. 1907/2006 see

www.stihl.com/reach

15 Maintenance and Repairs

Users of this machine may only carry out the maintenance and service work described in this user manual. All other repairs must be carried out by a servicing dealer.

STIHL recommends that you have servicing and repair work carried out exclusively by an authorized STIHL servicing dealer. STIHL dealers are regularly given the opportunity to attend training courses and are supplied with the necessary technical information.

When repairing the machine, only use replacement parts which have been approved by STIHL for this power tool or are technically identical. Only use high-quality replacement parts in order to avoid the risk of accidents and damage to the machine.

STIHL recommends the use of original STIHL replacement parts.

Original STIHL parts can be identified by the STIHL part number, the **STIHL** logo and the STIHL parts symbol  (the symbol may appear alone on small parts).

16 Disposal

Contact the local authorities or your STIHL servicing dealer for information on disposal.

Improper disposal can be harmful to health and pollute the environment.

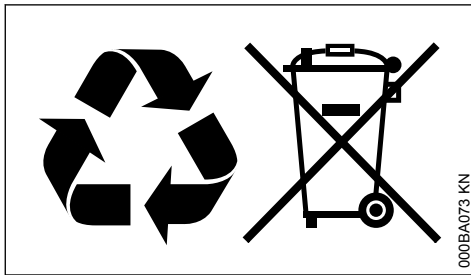

- ▶ Take STIHL products including packaging to a suitable collection point for recycling in accordance with local regulations.
- ▶ Do not dispose with domestic waste.

www.stihl.com



0458-483-0121-B



0458-483-0121-B